

BALDOR® • RELIANCE 

Product Information Packet

EM44256T-4

250HP, 1189RPM, 3PH, 60HZ, 449T, TEFC, F1

Part Detail							
Revision:	D	Status:	PRD/A	Change #:		Proprietary:	No
Type:	AC	Elec. Spec:	A44WG4238	CD Diagram:	416820-008	Mfg Plant:	
Mech. Spec:		Layout:	617427-209	Poles:	06	Created Date:	04-09-2015
Base:		Eff. Date:	02-06-2020	Leads:	6#1/0		

Specs			
Catalog Number:	EM44256T-4	Heater Indicator:	No Heater
Enclosure:	TEFC	Insulation Class:	F
Frame:	449T	Inverter Code:	Inverter Ready
Frame Material:	Iron	IP Rating:	NONE
Output @ Frequency:	250.000 HP @ 60 HZ	KVA Code:	G
Synchronous Speed @ Frequency:	1200 RPM @ 60 HZ	Motor Lead Quantity/Wire Size:	6 @ 1/0 AWG
Voltage @ Frequency:	460.0 V @ 60 HZ	Motor Type:	A44160M
XP Class and Group:	None	Mounting Arrangement:	F1
XP Division:	Not Applicable	Power Factor:	86
Agency Approvals:	CCSA US	Product Family:	General Industrial
	CSA EEV	Pulley End Bearing Type:	Ball
Auxillary Box:	No Auxillary Box	Pulley Face Code:	Standard
Base Indicator:	Rigid	Shaft Ground Indicator:	No Shaft Grounding
Bearing Grease Type:	Polyrex EM (-20F +300F)	Shaft Rotation:	Reversible
Current @ Voltage:	285.000 A @ 460.0 V	Shaft Slinger Indicator:	No Slinger
Design Code:	B	Speed Code:	Single Speed
Drip Cover:	No Drip Cover	Motor Standards:	NEMA
Duty Rating:	CONT	Starting Method:	Wye Start - Delta Run

Feedback Device:	NO FEEDBACK	Thermal Device - Bearing:	None
		Thermal Device - Winding:	None

Nameplate NP2496L

MOBIL POLYREX EM

Nameplate NP2349L											
SPEC NO.	A44-7107-4238			CAT.NO.	EM44256T-4			FRAME	449T		
HP	250	VOLTS	460	PHASE	3	DESIGN	B	TYPE	P		
RPM	1189	AMPS	285	HZ	60	AMB	40	SF	1.15		
DRIVE END BEARING	90BC03J30X		DUTY	CONT		INSUL.CLASS	F				
OPP D.E. BEARING	90BC03J30X		ENCL	TEFC		CODE	G				
SER.NO.				POWER FACTOR	86		NEMA-NOM-EFFICIENCY	95.8			
						MAX CORR KVAR	68.2		GUARANTEED EFFICIENCY		95
						NEMA NOM/CSA QUOTED EFF					
						MOTOR WEIGHT					

Parts List		
Part Number	Description	Quantity
SA296389	SA A44-7107-4238	1.000 EA
RA282429	RA A44-7107-4238	1.000 EA
421948044	LABEL, MYLAR	1.000 EA
NP2496L	MOTOR LUBE NAMEPLATE	1.000 EA
000613006PU	N/P (RELEASE QTY 10,000) UL CSA LABEL	1.000 EA
000692000FF	N/P	1.000 EA
000692000VD	LABEL WARNING	1.000 EA
NP2349L	SUPER-E ,SS, CSA, CSA SUPER-E	1.000 EA
089490099A	G28 BRKT 089490098WCA KB	1.000 EA
415072001B	CLAMP	1.000 EA
083199126A	G440 MOLDED FAN COVER	1.000 EA
034180014DA	KEY 1/4X1/4X1-3/4 L	1.000 EA
078557001E	FAN 440 078557001F	1.000 EA
004824015A	GREASE POLYREX EM	1.000 LB
032018020FK	HHCS 3/4-10X2-1/2 PLTD.	4.000 EA
032018008CK	HHCS 3/8-16X1L PLATED	4.000 EA
032018030DK	HHCS 1/2-13X3-3/4 PLTD.	3.000 EA
415096002A	CPLG 1/8 HEX TYPE	1.000 EA
034630002AB	CPLG 1/4" PLATED	1.000 EA
410700004A	WSHR	1.000 EA
034017014AB	LCKW 3/8 STD. PLATED	4.000 EA
034530064BB	P/NIP 1/4X8 PLATED	1.000 EA
034530064AB	P/NIP 1/8 X 8" L Pipe Nipple	1.000 EA
034690005AB	PPLG 3/4 PLATED	1.000 EA

Parts List (continued)		
Part Number	Description	Quantity
034690002AB	PPLG 1/4" PLTD.	1.000 EA
034690001AB	1/8" NPT SQHDPLG	1.000 EA
032620016LA	SOCKET SET SCREW-449	3.000 EA
702623022A	G28 AIR DEFLECTOR DRIVE END -- PLASTIC	1.000 EA
418151014G	RETAIN RING	1.000 EA
034630002AB	CPLG 1/4" PLATED	1.000 EA
034530064BB	P/NIP 1/4X8 PLATED	1.000 EA
034690002AB	PPLG 1/4" PLTD.	1.000 EA
034690001AB	1/8" NPT SQHDPLG	1.000 EA
702623013A	THERMAL BARRIER -- G28 -- BRACKET MTD	1.000 EA
032018004BK	HHCS 5/16-18X1/2 PLATED	3.000 EA
034017013AB	LCKW 5/16 STD. PLATED	3.000 EA
089490099A	G28 BRKT 089490098WCA KB	1.000 EA
032018020FK	HHCS 3/4-10X2-1/2 PLTD.	4.000 EA
032018030DK	HHCS 1/2-13X3-3/4 PLTD.	3.000 EA
034530064AB	P/NIP 1/8 X 8" L Pipe Nipple	1.000 EA
415096002A	CPLG 1/8 HEX TYPE	1.000 EA
032018006BK	HHCS 5/16-18X3/4 PLATED	3.000 EA
034001013AB	FLTW BAFFLE	3.000 EA
415915007G	GASK, LAC	1.000 FT
702658001B	+C/BOX, PAINTED 440	1.000 EA
702658002A	+C/BOX CVR, PAINTED 440	1.000 EA
406056008A	GASKET, TERBD 440	1.000 EA
418153001A	GASK 440	1.000 EA

Product Information Packet: EM44256T-4 - 250HP,1189RPM,3PH,60HZ,449T,TEFC,F1

418150003A	GREASE FITTING CAP	1.000 EA
MG1025Y17	WILKOFAS, 789.701, SUPER E PEARL GOLD	0.500 GA
032018008DK	HHCS 1/2-13X1 PLATED	4.000 EA
035000001A	ALFTG 1/8" 1610-BL	1.000 EA
415000103D	T/LUG #4AWG-1/0AWG W/HOLE FOR .250 BOLT	1.000 EA
033512006LB	HHTTS 1/4-20X3/4 PLTD.	8.000 EA
406099000A	PLUG - FAN COVER 320-440	1.000 EA
033512004LB	HHTTS 1/4-20X1/2 PLTD.	1.000 EA
035000001A	ALFTG 1/8" 1610-BL	1.000 EA
418150003A	GREASE FITTING CAP	1.000 EA
033775004EA	DRSCR #6-1/4 304 S.S.	2.000 EA
034180054KA	7/8 SQ X 6.75 KEY	1.000 EA
604797056	400-447 FRAME 60 X 42	1.000 EA
032510026D	CARRIAGE BOLT - 440	2.000 EA
034001014AB	FLAT WASHER 3/8" PLATED	2.000 EA
034001016AB	WSHR .562ID 1.375OD .109	2.000 EA
033300014AC	HEX NUT, SHIPPING - 400	2.000 EA
604799003C	PLASTIC BAG 42X32X46	1.000 EA

REL. S.O.	FRAME	HP	TYPE	PHASE/HERTZ	RPM	VOLTS
	449TD	250	P	3/60	1189	460
AMPS	DUTY	AMB °C/ INSUL.	S.F.	NEMA DESIGN	CODE LETTER	ENCL.
285	CONT	40/F	1.15	B	G	TEFC
E/S	ROTOR	TEST S.O.	TEST DATE	STATOR RES @25 °C (OHMS BETWEEN LINES)		
444238	418143090SE	---	---	.0162		

PERFORMANCE

LOAD	HP	AMPERES	RPM	POWER FACTOR %	EFFICIENCY %
NO LOAD	0	96.3	1200	3.61	0
1/4	62.6	117	1197	53.2	93.8
2/4	125	163	1195	75.1	95.8
3/4	187	220	1192	83.0	96.1
4/4	250	286	1189	85.5	95.8
5/4	312	358	1186	85.7	95.3

SPEED TORQUE

	RPM	TORQUE % FULL LOAD	TORQUE LB.-FT.	AMPERES
LOCKED ROTOR	0	162	1786	1849
PULL UP	240	142	1566	1791
BREAKDOWN	1148	252	2788	1052
FULL LOAD	1189	100	1104	286

AMPERES SHOWN FOR 460. VOLT CONNECTION. IF OTHER VOLTAGE CONNECTIONS ARE AVAILABLE, THE AMPERES WILL VARY INVERSELY WITH THE RATED VOLTAGE

REMARKS: TYPICAL DATA
 XE MOTOR--CALCULATED DATA--NEMA NOM. EFF. 95.8 PCT.

 A MEMBER OF THE ABB GROUP	DR. BY G. R. WEBB CR. BY W. I. SMITH APP. BY W. I. SMITH DATE 04/09/15	A-C MOTOR PERFORMANCE DATA A44WG4238-R001 ISSUE DATE 04/04/19
--	---	--

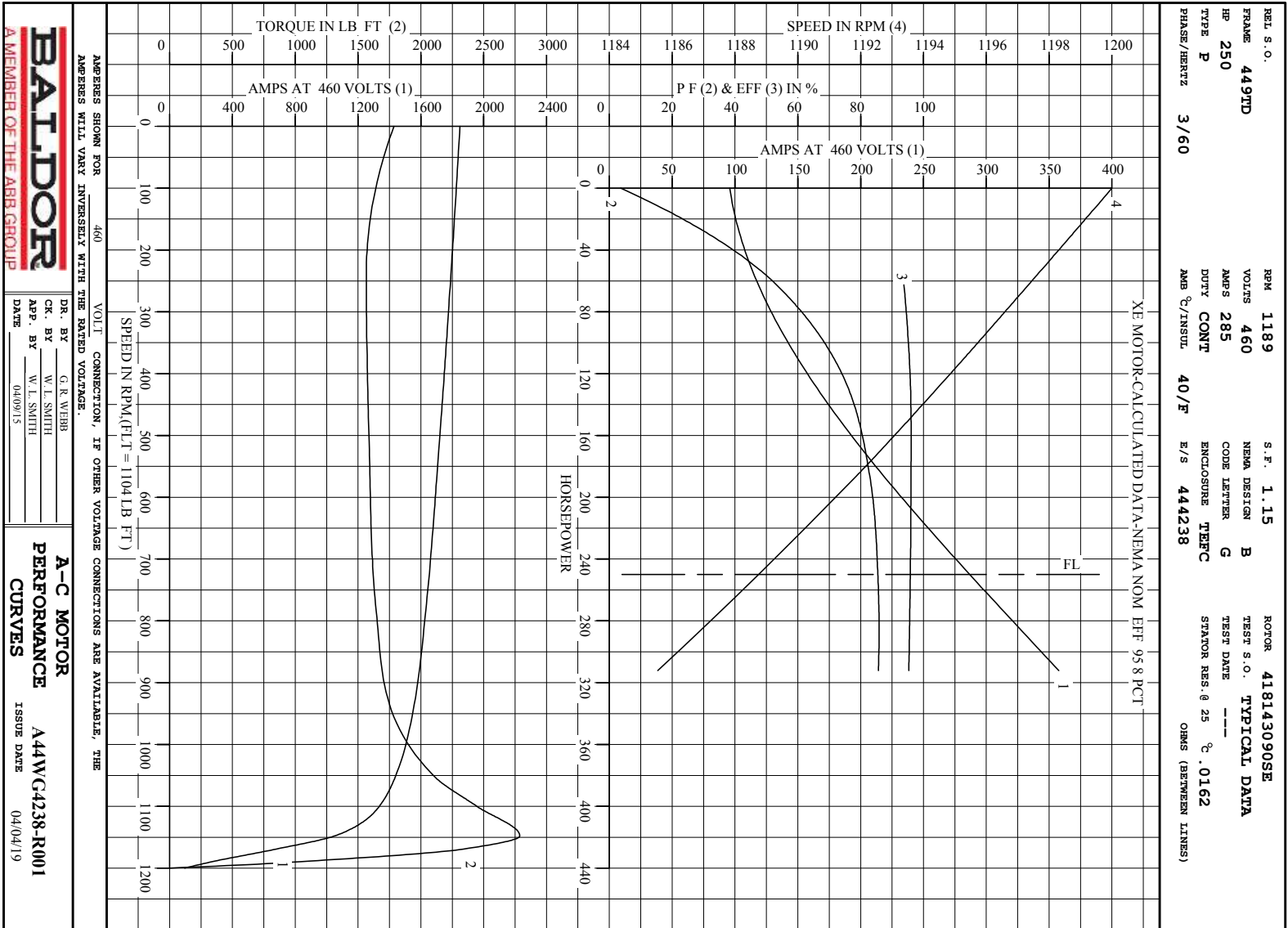

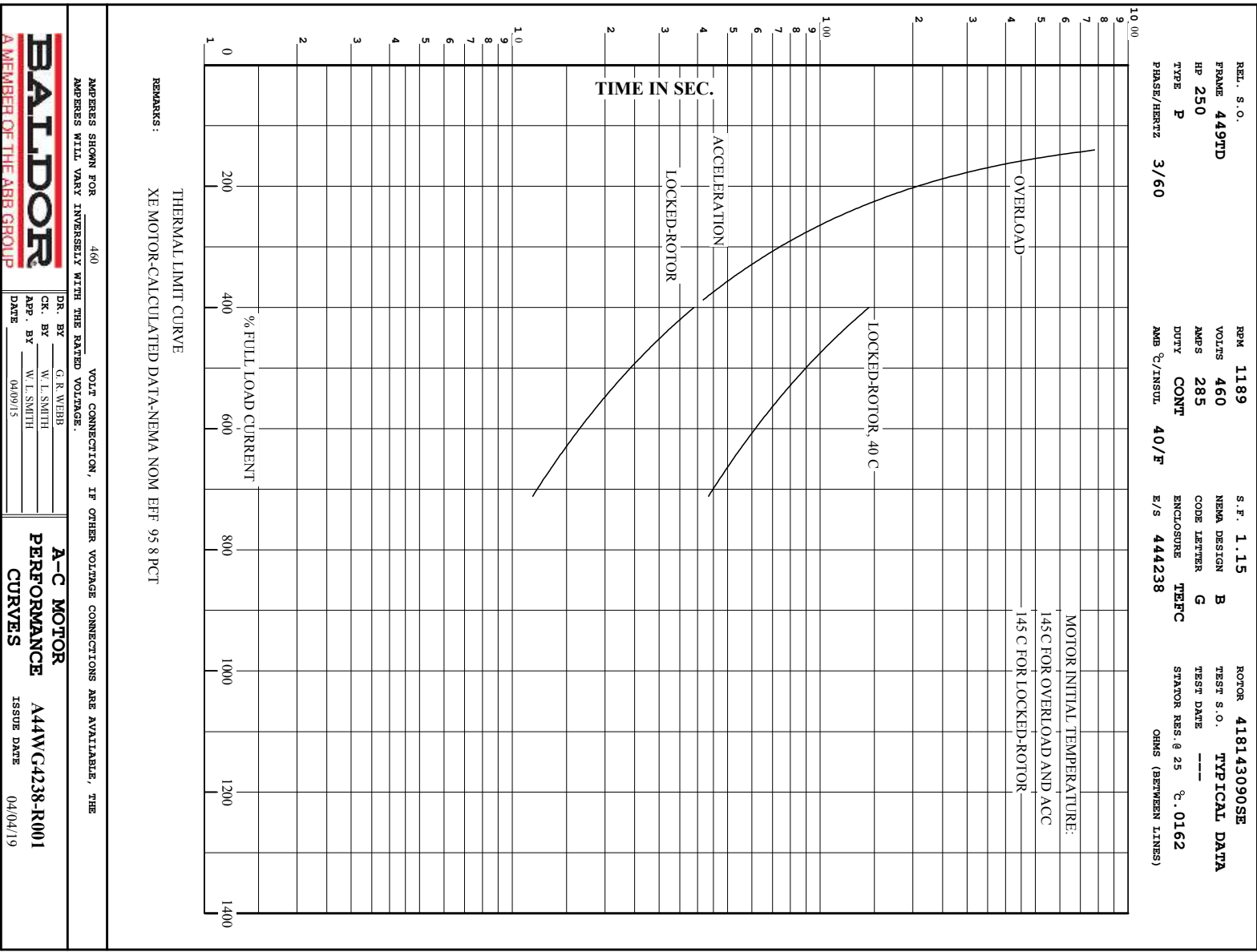

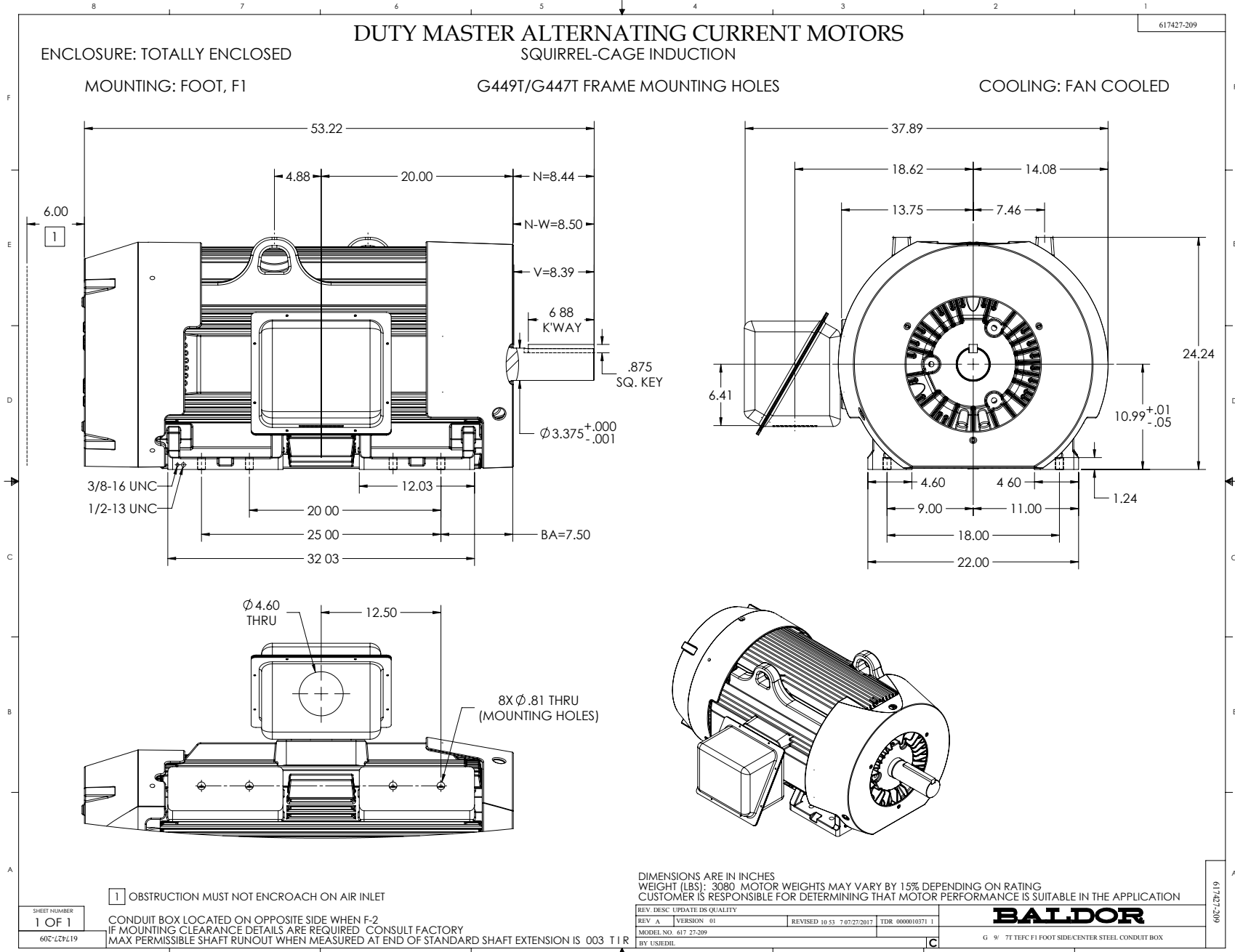

416820-008

A-C MOTOR CONNECTION DIAGRAM

STANDARD 6 LEAD

Y START - DELTA RUN

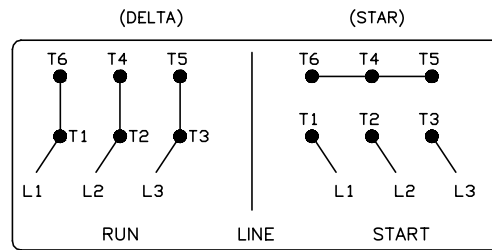
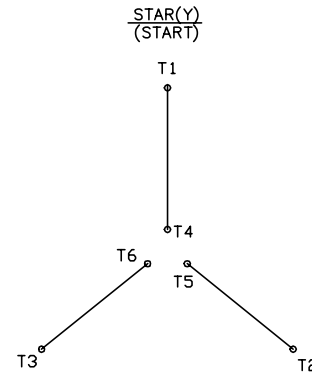
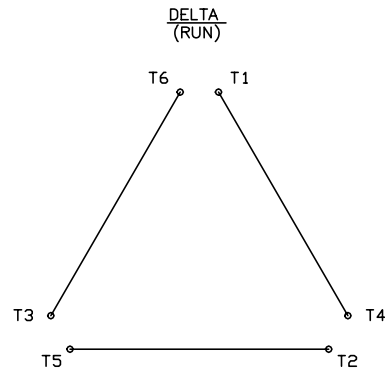

< N. P. 1767-DC >

REV. DESC: ADDED T4 TO Y CONNECT DIAGRAM		
REV. LTR: D	VERSION: 04	TDR: 00000847713
FILE: \RAG\00001\808	REVISED: 10: 41: 26 04/08/2014	BY: RAGJSS1
MTL: -	⊙ □	



CONNECT DIAGRAM STD 6 LEAD Y START DELTA RUN

SH 1 of 1

416820-008

Marketing maintained PDF of MN408:

[MN408?ManNumber=MN408](#)

Marketing maintained PDF of MN416:

[MN416?ManNumber=MN416](#)